

Hand Operated Curtain Pole System

Silent Gliss® 6140M Metropole 50mm

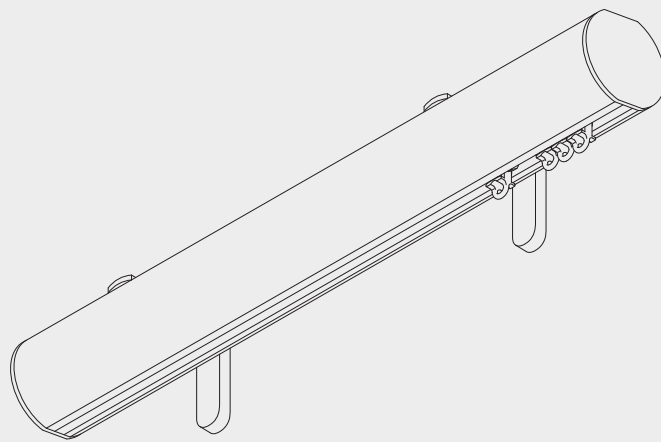

Product Information

- Hand operated system for domestic and contract applications
- Can be bent for bay windows
- Choice of 9 different finishes - black, white, matt white, ecru, slate grey, antique bronze, silver, anodic grey and taupe
- Accessorised with matching end caps brackets
- A selection of finials are available
- Easy wall or ceiling fix
- For medium to heavy curtains
- Suitable for use with Wave curtain heading system



6140M

Profile and Bending Information

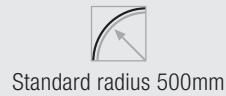
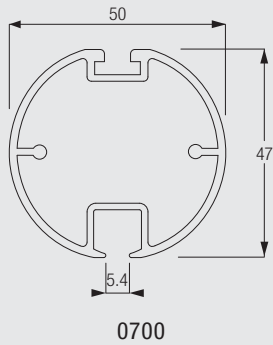

Specification Guide - download www.silentgliss.co.uk (password required)

Silent Gliss 6140M curtain track, hand drawn, aluminium, assembled complete with gliders 6143 at 10/m and 2 endcovers 0350. Face fix with brackets 11206-208/11216-218/11209/0334/ceiling fix with bracket 6138P2/0335 each screwed to timber /plugged and screwed to block-work/concrete at 600mm centres. Finished in black, white, matt white, ecru, slate grey, antique bronze, taupe, silver, anodic grey or taupe.

How To Measure

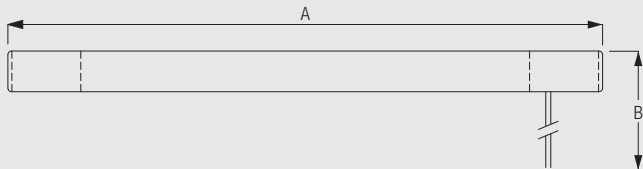

A: System Width - includes finials. See 'Design Options' for finial sizes.

Stack Size Calculation Wave Standard

6140M

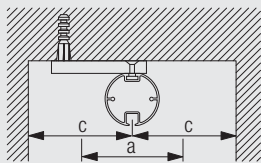
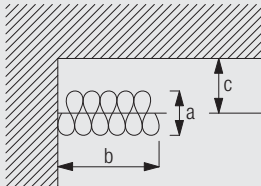

a = Stack depth
b = Stack size
c = Min. distance

Glider-cord spacing	Curtain hook spacing	Approx. curtain fullness	Stack depth (a)	Stack width (b)	Min distance (c)
6	10	2.1	10	23 per metre of track + endpiece	8
6	12	2.3	12	23 per metre of track + endpiece	9
8	14	2.1	14	18 per metre of track + endpiece	10
8	16	2.3	16	18 per metre of track + endpiece	11

Wave standard with roller gliders

Glider-cord spacing	Curtain hook spacing	Approx. curtain fullness	Stack depth (a)	Stack width (b)	Min distance (c)
8	14	2.1	14	21 per metre of track + endpiece	10
8	16	2.3	16	21 per metre of track + endpiece	11

(dimensions in cm)

Note: Minimum distance (c) includes a standard 3cm clearance (front and back).

Design Options

Endcaps

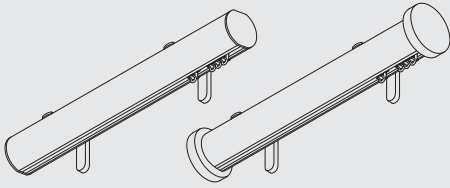

Without finials, poles are supplied as standard with flush fitting endcaps 0350 (left). Alternatively, stud endcaps 0714 (right) can be selected at no additional cost.

Finials

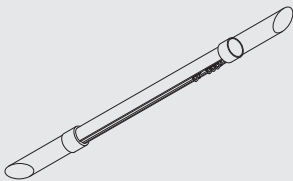

Finials are decorative elements that fit on at the end of the pole.

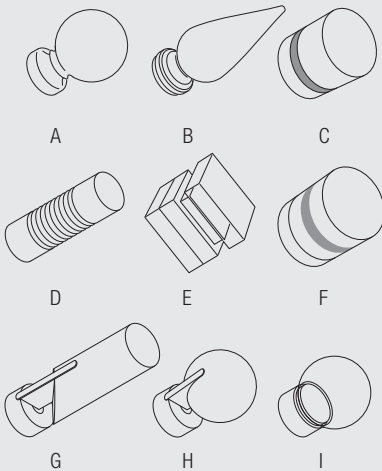

- A: 0717 Ball End 125mm
- B: 0718 Real Wood Spear 150mm
- C: 0697 Strata 65mm
- D: 0630 Groove Cylinder 125mm
- E: 0898 Crystal Cube 55mm
- F: 0899 Crystal Cylinder 55mm
- G: Fused Barrel 121mm (walnut/oak/matched)
- H: Fused Ball 81mm (walnut/oak/matched)
- I: Glass Ball (clear/frosted) 70mm



6140M

Wave Standard curtain heading system

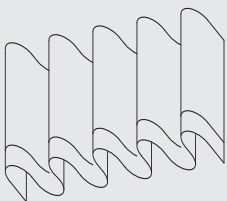

Wave is an exciting contemporary curtain heading system which allows curtains to hang in a continuous wave which is smooth, simple and elegant.

When using the Wave curtain heading system please note the maximum recommended curtain weight is 2.5kg/m or 10kg/m with wave roller gliders 6098W.

The Wave standard components are:

- 6345 Glider Cord 60mm
- 6346 Glider Cord 80mm
- 6007 End stop

The items listed below for Enhanced Wave (80mm glider cord only) are all supplied at an additional cost as per the price list.

- 2255 Adjustable brake
- 6364 Extension (for use with 6365)
- 6365 Hanger (for use with 6364)
- 6366 Carrier for draw rod

Roller gliders must be ordered separately
6098W Wave roller glider 80mm

Optional enhanced components to improve the presentation of the curtain:

- 3582 Hook
- 6349 Curtain tape
- 6363 Iron-on top hemming tape
- 10075 Lead weight for bottom hem 50gr/m
- 10076 Fabric weight for side of curtain

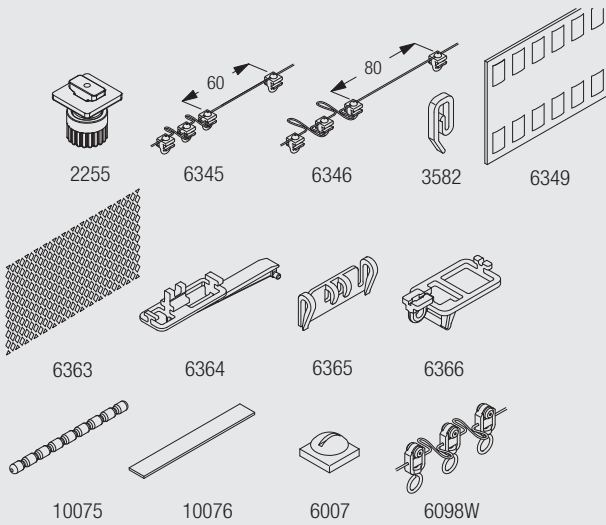

Connecting Profiles

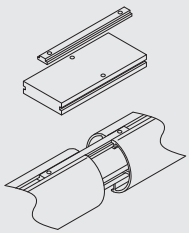

Profiles can be joined with Connecting Bridge 0273.



6140M

Fitting Information

Bracket positioning

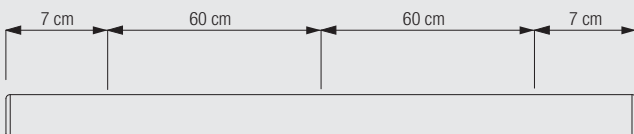

Fitting of track to bracket

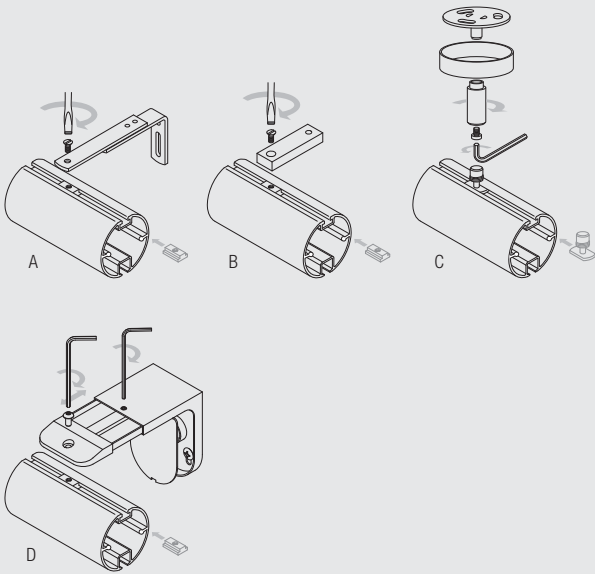

- A: Using adjustable bracket set 11209
- B: Using ceiling fix bracket 6138p
- C: Using top fix bracket 0335
- D: Using maxi adjustable bracket 0334

All 50mm Metropole are supplied with Maxi bracket 0334 as standard unless otherwise specified.

Fitting Options

Wall fix with Smart Fix adjustable brackets 11209

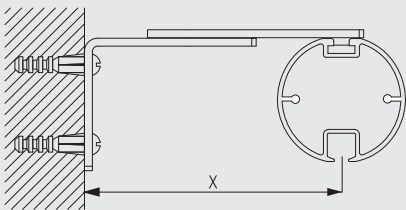

	X (mm)
11209	80-100

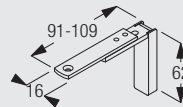

11209
Smart Fix with
extension arm set

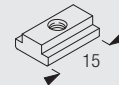

6141
Track insert (uses
screw 0798)



6140M

Ceiling fix with 6138P2

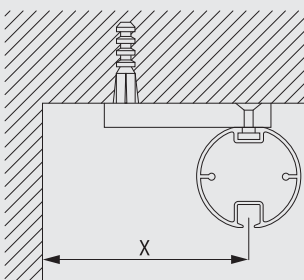

	X (mm)
6138P2	80

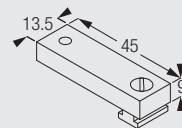

6138P2
Ceiling support set
(9mm)

Ceiling fix with top fix bracket 0335

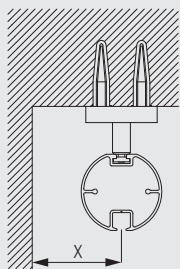

X (mm)
50



0335
Top fix bracket

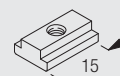

6141
Track insert (uses
screw 0798)

Wall fix with maxi adjustable bracket 0334

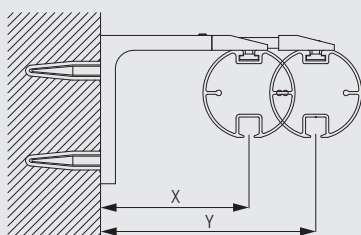

	X (mm)	Y (mm)
0334	80	100

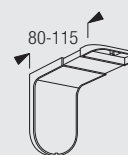

0334
Maxi adjustable
bracket

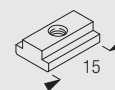

6141
Track insert (uses
screw 0798)

Wall fitting with Smart Fix with slot 11206-11208

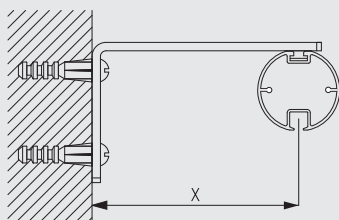

	X (mm)
11206	33-51
11207	53-71
11208	73-91



6141
Track insert (uses
screw 0798)

Wall fitting with Square Smart Fix with slot 11216-11218

6140M

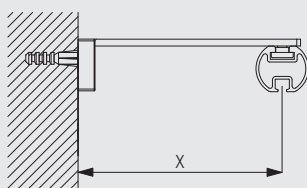

	X (mm)
11216	33-51
11217	53-71
11218	73-91

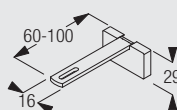

11216-18
Square Smart Fix
with slot (60-100
mm)

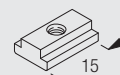

6141
Track insert (uses
screw 0798)

Standard Accessories

Parts

0334 Maxi adjustable bracket



0350 Flush endcap (50mm)



0700 Profile 50mm



6065 Twist eye endstop



6141 Track insert (uses screw 0798)



6143 Glider 6144 in strip form













Optional Accessories

Parts

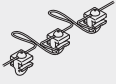
0273	Connecting Bridge for System 6140		0315	Fused barrel (50mm)	
0327	Fused ball (50mm)		0333	Glass ball (50mm)	
0335	Top fix bracket		0630	Groove Cylinder (50mm)	
0697	Strata (50mm)		0714	Stud End cap (50mm)	
0717	Ball end finial (50mm pole)		0718	Spear finial (50mm pole)	
0898	Crystal Square (50mm)		0899	Crystal Cylinder (50mm)	
6283	Roller glider		11206	Smart Fix, 60 mm with slot set	
11207	Smart Fix, 80 mm with slot set		11208	Smart Fix, 100 mm with slot set	
11209	Smart Fix with extension arm set		11216	Square Smart Fix, 60 mm with slot set	
11217	Square Smart Fix, 80 mm with slot set		11218	Square Smart Fix, 100 mm with slot set	
6138P2	Ceiling support set (9mm)				

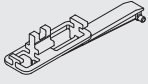

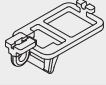
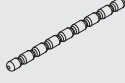
Wave Accessories

2255	Adjustable brake		3582	Hook	
6007	Endstop		6345	Wave glider cord (60mm)	
6346	Wave glider cord (80mm)		6349	Curtain tape	
6363	Top hemming tape		6364	Extension	
6365	Hanger		6366	Wave carrier for draw rod	
10075	Lead weight 50 gr/m		10076	Fabric weight	
6098W	Wave roller glider cord (80mm)				



6140M